

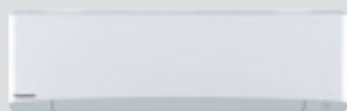

Wiring diagrams

Wall-mounted kits 1x1

Indoor unit



Outdoor unit



Attention: Wall-mounted Etherea have different connection terminals



Single phase
Power source
230 V / 50 Hz



Infrared remote controller (included in the delivery)

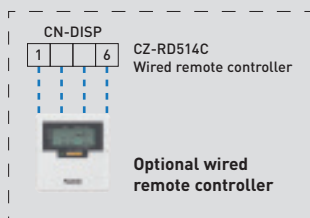

Optional wired remote controller

Power source to indoor or outdoor depending on model, see table.

Wall-mounted Heatcharge VZ R32

Indoor unit	Power source	Recommended fuse	Power supply cable	Connection indoor / outdoor	Outdoor unit
CS-VZ9SKE	230 V (Outdoor)	16 A	3 x 1,5 mm ²	4 x 1,5 mm ²	CU-VZ9SKE
CS-VZ12SKE	230 V (Outdoor)	16 A	3 x 1,5 mm ²	4 x 1,5 mm ²	CU-VZ12SKE

Wall-mounted Etherea Silver / Pure White Matt R32

Indoor unit	Power source	Recommended fuse	Power supply cable	Connection indoor / outdoor	Outdoor unit
CS-XZ20VKEW / CS-Z20VKEW	230 V (Indoor)	16 A	3 x 1,5 mm ²	4 x 1,5 mm ²	CU-Z20VKE
CS-XZ25VKEW / CS-Z25VKEW	230 V (Indoor)	16 A	3 x 1,5 mm ²	4 x 1,5 mm ²	CU-Z25VKE
CS-XZ35VKEW / CS-Z35VKEW	230 V (Indoor)	16 A	3 x 1,5 mm ²	4 x 1,5 mm ²	CU-Z35VKE
— / CS-Z42VKEW	230 V (Indoor)	16 A	3 x 1,5 mm ²	4 x 2,5 mm ²	CU-Z42VKE
CS-XZ50VKEW / CS-Z50VKEW	230 V (Indoor)	16 A	3 x 1,5 mm ²	4 x 2,5 mm ²	CU-Z50VKE
— / CS-Z71VKEW	230 V (Indoor)	20 A	3 x 1,5 mm ²	4 x 2,5 mm ²	CU-Z71VKE

Wall-mounted TZ super-compact R32

Indoor unit	Power source	Recommended fuse	Power supply cable	Connection indoor / outdoor	Outdoor unit
CS-TZ20WKEW	230 V (Indoor)	16 A	3 x 1,5 mm ²	4 x 1,5 mm ²	CU-TZ20WKE
CS-TZ25WKEW	230 V (Indoor)	16 A	3 x 1,5 mm ²	4 x 1,5 mm ²	CU-TZ25WKE
CS-TZ35WKEW	230 V (Indoor)	16 A	3 x 1,5 mm ²	4 x 1,5 mm ²	CU-TZ35WKE
CS-TZ42WKEW	230 V (Indoor)	16 A	3 x 1,5 mm ²	4 x 1,5 mm ²	CU-TZ42WKE
CS-TZ50WKEW	230 V (Indoor)	16 A	3 x 2,5 mm ²	4 x 2,5 mm ²	CU-TZ50WKE
CS-TZ60WKEW	230 V (Indoor)	16 A	3 x 2,5 mm ²	4 x 2,5 mm ²	CU-TZ60WKE
CS-TZ71WKEW	230 V (Indoor)	20 A	3 x 2,5 mm ²	4 x 2,5 mm ²	CU-TZ71WKE

Wall-mounted FZ super-compact R32

Indoor unit	Power source	Recommended fuse	Power supply cable	Connection indoor / outdoor	Outdoor unit
CS-FZ25WKE	230 V (Indoor)	16 A	3 x 1,5 mm ²	4 x 1,5 mm ²	CU-FZ25WKE
CS-FZ35WKE	230 V (Indoor)	16 A	3 x 1,5 mm ²	4 x 1,5 mm ²	CU-FZ35WKE
CS-FZ50WKE	230 V (Indoor)	16 A	3 x 2,5 mm ²	4 x 2,5 mm ²	CU-FZ50WKE
CS-FZ60WKE	230 V (Indoor)	16 A	3 x 2,5 mm ²	4 x 2,5 mm ²	CU-FZ60WKE

Wall-mounted UZ super-compact R32

Indoor unit	Power source	Recommended fuse	Power supply cable	Connection indoor / outdoor	Outdoor unit
CS-UZ25WKE	230 V (Indoor)	16 A	3 x 1,5 mm ²	4 x 1,5 mm ²	CU-UZ25WKE
CS-UZ35WKE	230 V (Indoor)	16 A	3 x 1,5 mm ²	4 x 1,5 mm ²	CU-UZ35WKE
CS-UZ50WKE	230 V (Indoor)	16 A	3 x 1,5 mm ²	4 x 1,5 mm ²	CU-UZ50WKE

Wall-mounted PZ super-compact R32

Indoor unit	Power source	Recommended fuse	Power supply cable	Connection indoor / outdoor	Outdoor unit
CS-PZ25WKE	230 V (Indoor)	16 A	3 x 1,5 mm ²	4 x 1,5 mm ²	CU-PZ25WKE
CS-PZ35WKE	230 V (Indoor)	16 A	3 x 1,5 mm ²	4 x 1,5 mm ²	CU-PZ35WKE
CS-PZ50WKE	230 V (Indoor)	16 A	3 x 1,5 mm ²	4 x 1,5 mm ²	CU-PZ50WKE

Wall-mounted Professional kits 1x1

Indoor unit

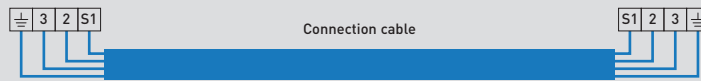
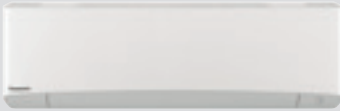

Outdoor unit



CN-RMT
CZ-RD514C
Included wired remote controller

Single phase
Power source
230 V / 50 Hz

Wall-mounted Professional -20 °C R32

Indoor unit	Power source	Recommended fuse	Connection indoor / outdoor	Outdoor unit
CS-Z25TKEA	230 V (Indoor)	16 A	4 x 1,5 mm ²	CU-Z25TKEA
CS-Z35TKEA	230 V (Indoor)	16 A	4 x 1,5 mm ²	CU-Z35TKEA
CS-Z42TKEA	230 V (Indoor)	16 A	4 x 1,5 mm ²	CU-Z42TKEA
CS-Z50TKEA	230 V (Indoor)	16 A	4 x 2,5 mm ²	CU-Z50TKEA
CS-Z71TKEA	230 V (Indoor)	20 A	4 x 2,5 mm ²	CU-Z71TKEA

Wall-mounted Professional -20 °C R410A

Indoor unit	Power source	Recommended fuse	Connection indoor / outdoor	Outdoor unit
CS-E9PKEA	230 V (Indoor)	16 A	4 x 1,5 mm ²	CU-E9PKEA
CS-E12PKEA	230 V (Indoor)	16 A	4 x 1,5 mm ²	CU-E12PKEA
CS-E15PKEA	230 V (Indoor)	16 A	4 x 1,5 mm ²	CU-E15PKEA
CS-E18PKEA	230 V (Indoor)	16 A	4 x 2,5 mm ²	CU-E18PKEA

Floor Console kits 1x1

Indoor unit

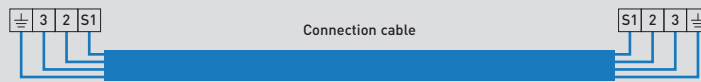

Outdoor unit



Infrared remote controller (included in the delivery)



Single phase
Power source
230 V / 50 Hz

Floor Console R32

Indoor unit	Power source	Recommended fuse	Connection indoor / outdoor	Outdoor unit
CS-Z25UFEAW	230 V (Outdoor)	16 A	3 x 1,5 mm ²	CU-Z25UBEA
CS-Z35UFEAW	230 V (Outdoor)	16 A	3 x 1,5 mm ²	CU-Z35UBEA
CS-Z50UFEAW	230 V (Outdoor)	16 A	3 x 2,5 mm ²	CU-Z50UBEA

4 Way 60x60 Cassette kits 1x1

Indoor unit

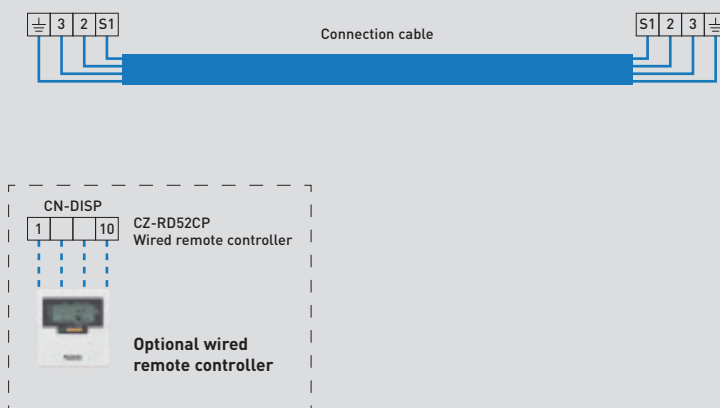

Outdoor unit

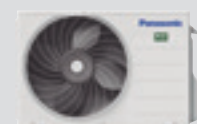

Single phase
Power source
230 V / 50 Hz

4 Way 60x60 Cassette R32

Indoor unit	Power source	Recommended fuse	Connection indoor / outdoor	Outdoor unit
CS-Z25UB4EAW	230 V (Outdoor)	16 A	4 x 1,5 ~ 2,5 mm ²	CU-Z25UBEA
CS-Z35UB4EAW	230 V (Outdoor)	16 A	4 x 1,5 ~ 2,5 mm ²	CU-Z35UBEA
CS-Z50UB4EAW	230 V (Outdoor)	16 A	4 x 1,5 ~ 2,5 mm ²	CU-Z50UBEA
CS-Z60UB4EAW	230 V (Outdoor)	16 A	4 x 1,5 ~ 2,5 mm ²	CU-Z60UBEA

Low Static Pressure Hide Away kits 1x1

Indoor unit

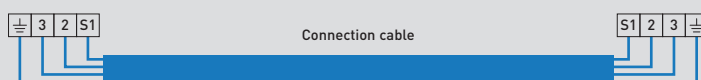
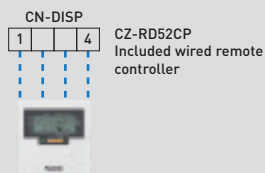

Outdoor unit

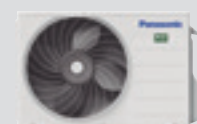

Single phase
Power source
230 V / 50 Hz

Low Static Pressure Hide Away R32

Indoor unit	Power source	Recommended fuse	Connection indoor / outdoor	Outdoor unit
CS-Z25UD3EAW	230 V (Outdoor)	16 A	4 x 1,5 ~ 2,5 mm ²	CU-Z25UBEA
CS-Z35UD3EAW	230 V (Outdoor)	16 A	4 x 1,5 ~ 2,5 mm ²	CU-Z35UBEA
CS-Z50UD3EAW	230 V (Outdoor)	16 A	4 x 1,5 ~ 2,5 mm ²	CU-Z50UBEA
CS-Z60UD3EAW	230 V (Outdoor)	16 A	4 x 1,5 ~ 2,5 mm ²	CU-Z60UBEA

Free Multi System 2 Rooms

Indoor unit

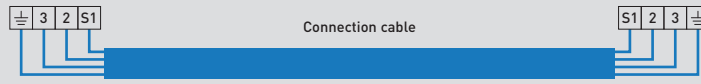
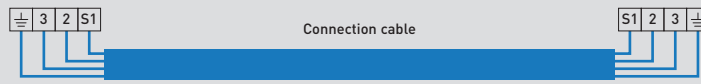
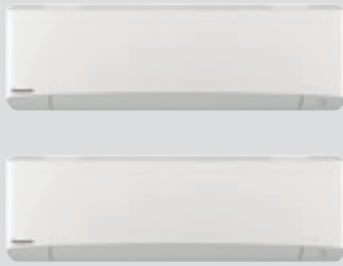

Attention: Wall-mounted Etherea have different connection terminals (Multi Split)

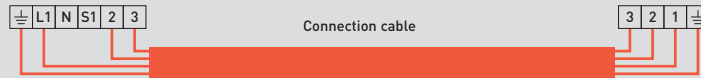

Outdoor unit



Single phase
Power source
230 V / 50 Hz / 16 A

Free Multi System R32

Outdoor unit	Recommended fuse	Power supply cable	Connection indoor / outdoor
CU-2Z35TBE	16 A	3 x 1.5 mm ²	4 x 1,5 mm ²
CU-2Z41TBE	16 A	3 x 1.5 mm ²	4 x 1,5 mm ²
CU-2Z50TBE	16 A	3 x 1.5 mm ²	4 x 1,5 mm ²
CU-2TZ41TBE	16 A	3 x 1.5 mm ²	4 x 1,5 mm ²
CU-2TZ50TBE	16 A	3 x 1.5 mm ²	4 x 1,5 mm ²

Free Multi System 3 Rooms

Indoor unit

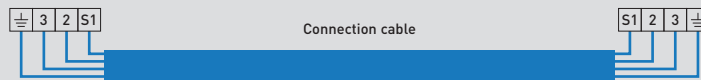
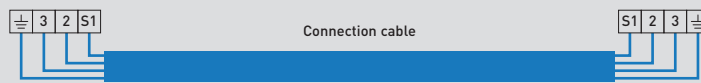
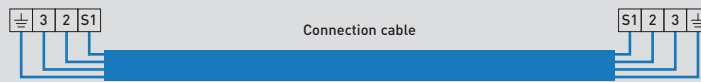

Attention: Wall-mounted Etherea have different connection terminals (Multi Split)

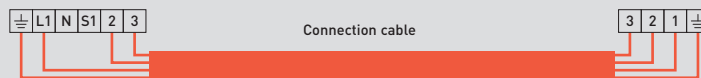

Outdoor unit



Single phase
Power source
230 V / 50 Hz / 16 A

Free Multi System R32

Outdoor unit	Recommended fuse	Power supply cable	Connection indoor / outdoor
CU-3Z52TBE	16 A	3 x 2.5 mm ²	4 x 1,5 mm ²
CU-3Z68TBE	16 A	3 x 2.5 mm ²	4 x 1,5 mm ²
CU-3TZ52TBE	16 A	3 x 2.5 mm ²	4 x 1,5 mm ²

Free Multi System 4 Rooms

Indoor unit

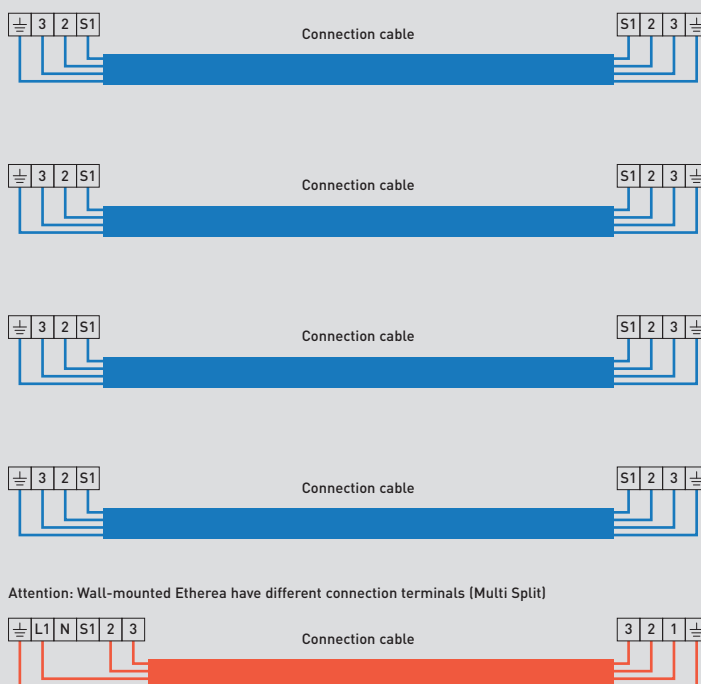

Outdoor unit



Single phase
Power source
230 V / 50 Hz / 20 A

Free Multi System R32

Outdoor unit	Recommended fuse	Power supply cable	Connection indoor / outdoor
CU-4Z68TBE	20 A	3 x 2,5 mm ²	4 x 1,5 mm ²
CU-4Z80TBE	20 A	3 x 2,5 mm ²	4 x 1,5 mm ²

Free Multi System 5 Rooms

Indoor unit

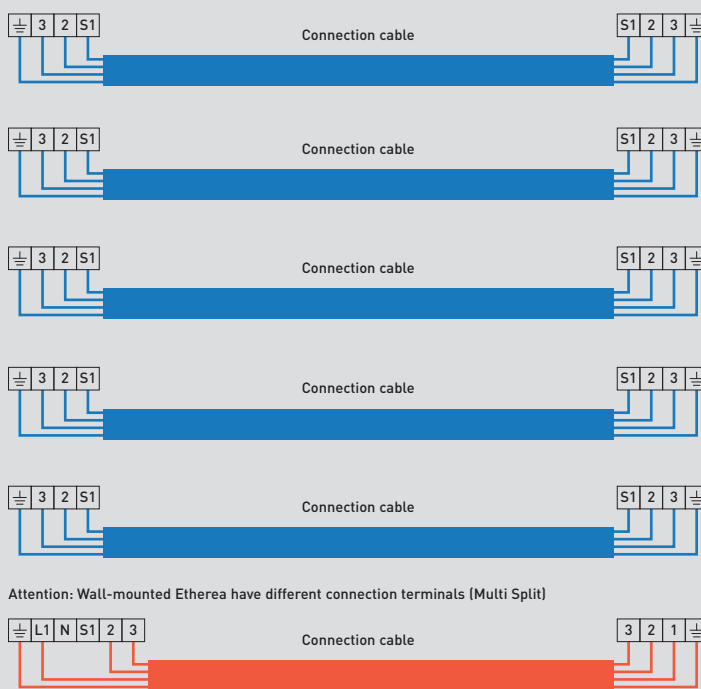

Outdoor unit



Single phase
Power source
230 V / 50 Hz / 25 A

Free Multi System R32

Outdoor unit	Recommended fuse	Power supply cable	Connection indoor / outdoor
CU-5Z90TBE	25 A	3 x 4,0 mm ²	4 x 1,5 mm ²

PACi Wall-mounted kits 1x1

Indoor unit

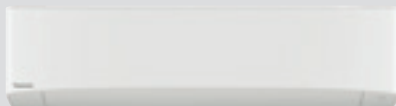

Outdoor unit

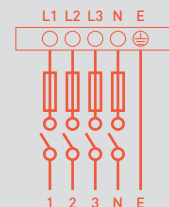
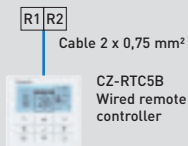
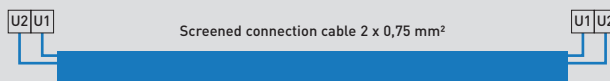

Single phase
Power source
230 V / 50 Hz / 3 A

Single phase
Power source
230 V / 50 Hz / *

Three phase
Power source
3 x 400 V / 1 N - 50 Hz / **

Single Phase

Indoor unit	Power source	R32 Outdoor unit	Power source	Circuit breaker*	R410A Outdoor unit	Power source	Circuit breaker*
S-36PK2E5B	220 / 230 / 240 V	U-36PZH2E5	220 / 230 / 240 V	16 A	U-36PE2E5A	220 / 230 / 240 V	16 A
S-50PK2E5B		U-50PZH2E5		16 A	U-50PE2E5A		16 A
S-60PK2E5B		U-60PZH2E5		20 A	U-60PE2E5A		20 A
S-71PK2E5B		U-71PZH2E5		20 A	U-71PE1E5A		20 A
S-100PK2E5B		U-100PZH2E5		30 A	U-100PE1E5A		30 A
S-60PK2E5B		U-60PZ2E5		20 A	U-60PEY2E5		20 A
S-71PK2E5B		U-71PZ2E5		20 A	U-71PEY2E5		20 A
S-100PK2E5B		U-100PZ2E5		30 A	U-100PEY1E5		30 A

Three Phase

Indoor unit	Power source	R32 Outdoor unit	Power source	Circuit breaker**	R410A Outdoor unit	Power source	Circuit breaker**
S-71PK2E5B	220 / 230 / 240 V	U-71PZH2E8	380 / 400 / 415 V	10 A	U-71PE1E8A	380 / 400 / 415 V	10 A
S-100PK2E5B		U-100PZH2E8		10 A	U-100PE1E8A		10 A
S-100PK2E5B		U-100PZ2E8		10 A	U-100PEY1E8		10 A

PACi 4 Way 60x60 Cassette kits 1x1

Indoor unit



Outdoor unit

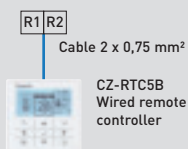
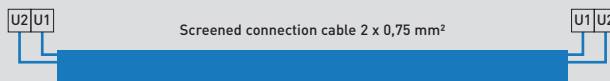

Single phase
Power source
230 V / 50 Hz / 3 A

Single phase
Power source
230 V / 50 Hz / 16 A

Single phase

Indoor unit	Power source	R32 Outdoor unit	Power source	Circuit breaker	R410A Outdoor unit	Power source	Circuit breaker
S-36PY2E5B	220 / 230 / 240 V	U-36PZH2E5	220 / 230 / 240 V	16 A	U-36PE2E5A	220 / 230 / 240 V	16 A
S-50PY2E5B		U-50PZH2E5		16 A	U-50PE2E5A		16 A

BIG PACi High Static Pressure Hide Away 20,0-25,0 kW kits 1x1

Indoor unit

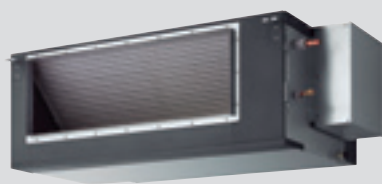

Outdoor unit



Single phase
Power source
230 V / 50 Hz / 10 A

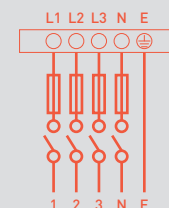
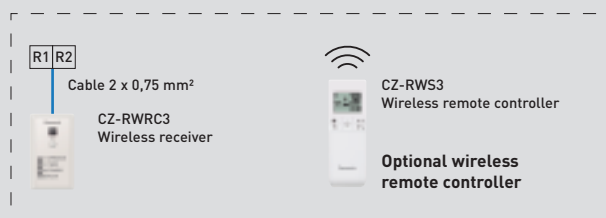
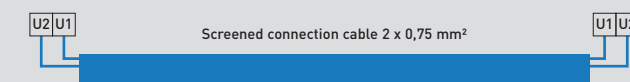
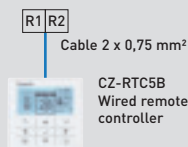

Three phase
Power source
3 x 400 V / 1 N - 50 Hz / *

Three phase

		R32			R410A		
Indoor unit	Power source	Outdoor unit	Power source	Circuit breaker*	Outdoor unit	Power source	Circuit breaker*
S-200PE3E5B	220 / 230 / 240 V	U-200PZH2E8	380 / 400 / 415 V	16 A	U-200PE2E8A	380 / 400 / 415 V	25 A
S-250PE3E5B		U-250PZH2E8		20 A	U-250PE2E8A		25 A

PACi 4 Way 90x90 Cassette kits 1x1

Indoor unit



Outdoor unit



Single phase
Power source
230 V / 50 Hz / 3 A

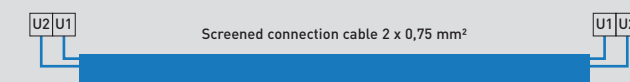
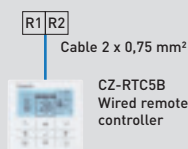

Single phase
Power source
230 V / 50 Hz / *

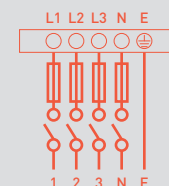

Three phase
Power source
3 x 400 V / 1 N - 50 Hz / **

		R32			R410A		
Indoor unit	Power source	Outdoor unit	Power source	Circuit breaker**	Outdoor unit	Power source	Circuit breaker**
Single Phase	220 / 230 / 240 V	S-36PU2E5B	U-36PZH2E5	16 A	U-36PE2E5A	220 / 230 / 240 V	16 A
		S-50PU2E5B	U-50PZH2E5	16 A	U-50PE2E5A		16 A
		S-60PU2E5B	U-60PZH2E5	20 A	U-60PE2E5A		20 A
		S-71PU2E5B	U-71PZH2E5	20 A	U-71PE1E5A		20 A
		S-100PU2E5B	U-100PZH2E5	25 A	U-100PE1E5A		30 A
		S-125PU2E5B	U-125PZH2E5	30 A	U-125PE1E5A		30 A
		S-140PU2E5B	U-140PZH2E5	30 A	U-140PE1E5A		40 A
		S-60PU2E5B	U-60PZ2E5	20 A	U-60PEY2E5		20 A
		S-71PU2E5B	U-71PZ2E5	20 A	U-71PEY2E5		20 A
		S-100PU2E5B	U-100PZ2E5	30 A	U-100PEY1E5		30 A
S-125PU2E5B	U-125PZ2E5	30 A	U-125PEY1E5	30 A			
S-140PU2E5B	U-140PZ2E5	40 A					
Three Phase	220 / 230 / 240 V	S-71PU2E5B	U-71PZH2E8	10 A	U-71PE1E8A	380 / 400 / 415 V	10 A
		S-100PU2E5B	U-100PZH2E8	10 A	U-100PE1E8A		10 A
		S-125PU2E5B	U-125PZH2E8	16 A	U-125PE1E8A		16 A
		S-140PU2E5B	U-140PZH2E8	16 A	U-140PE1E8A		16 A
		S-100PU2E5B	U-100PZ2E8	10 A	U-100PEY1E8		10 A
		S-125PU2E5B	U-125PZ2E8	16 A	U-125PEY1E8		16 A
		S-140PU2E5B	U-140PZ2E8	16 A	U-140PEY1E8		16 A

PACi Ceiling kits 1x1

Indoor unit

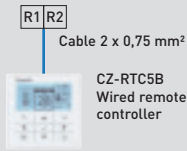

CZ-RTC5B
Wired remote controller

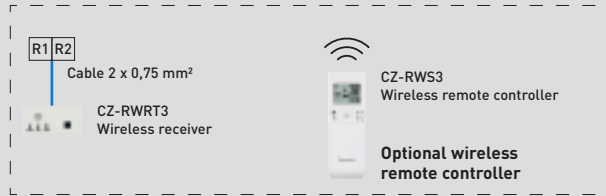
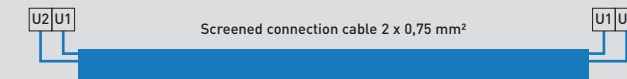

Optional wireless remote controller



Outdoor unit

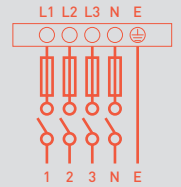

Single phase
Power source
230 V / 50 Hz / 3 A

Single phase
Power source
230 V / 50 Hz / *

Three phase
Power source
3 x 400 V / 1 N - 50 Hz / **

Single phase

Indoor unit	Power source	R32		R410A		
		Outdoor unit	Power source	Outdoor unit	Power source	
S-36PT2E5B	220 / 230 / 240 V	U-36PZH2E5	220 / 230 / 240 V	16 A	U-36PE2E5A	16 A
S-50PT2E5B		U-50PZH2E5		16 A	U-50PE2E5A	16 A
S-60PT2E5B		U-60PZH2E5		20 A	U-60PE2E5A	20 A
S-71PT2E5B		U-71PZH2E5		20 A	U-71PE1E5A	20 A
S-100PT2E5B		U-100PZH2E5		30 A	U-100PE1E5A	30 A
S-125PT2E5B		U-125PZH2E5		30 A	U-125PE1E5A	30 A
S-140PT2E5B		U-140PZH2E5		30 A	U-140PE1E5A	40 A
S-60PT2E5B		U-60PZ2E5		20 A	U-60PEY2E5	20 A
S-71PT2E5B		U-71PZ2E5		20 A	U-71PEY2E5	20 A
S-100PT2E5B		U-100PZ2E5		30 A	U-100PEY1E5	30 A
S-125PT2E5B		U-125PZ2E5		30 A	U-125PEY1E5	30 A
S-140PT2E5B		U-140PZ2E5		40 A		

Three phase

Indoor unit	Power source	R32		R410A	
		Outdoor unit	Power source	Outdoor unit	Power source
S-71PT2E5B	220 / 230 / 240 V	U-71PZH2E8	380 / 400 / 415 V	U-71PE1E8A	10 A
S-100PT2E5B		U-100PZH2E8		U-100PE1E8A	10 A
S-125PT2E5B		U-125PZH2E8		U-125PE1E8A	16 A
S-140PT2E5B		U-140PZH2E8		U-140PE1E8A	16 A
S-100PT2E5B		U-100PZ2E8		U-100PEY1E8	10 A
S-125PT2E5B		U-125PZ2E8		U-125PEY1E8	16 A
S-140PT2E5B		U-140PZ2E8		U-140PEY1E8	16 A

PACi Hide Away kits 1x1

Indoor unit

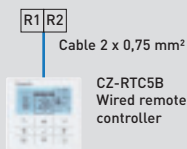
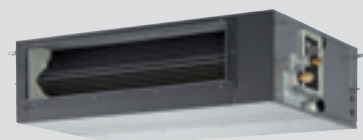

CZ-RTC5B
Wired remote controller

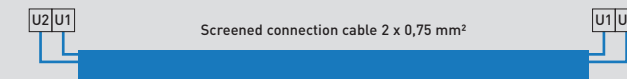

Optional wireless remote controller



Outdoor unit

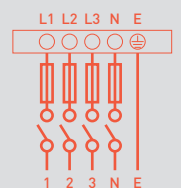

Single phase
Power source
230 V / 50 Hz / 3 A

Single phase
Power source
230 V / 50 Hz / *

Three phase
Power source
3 x 400 V / 1 N - 50 Hz / **

	High Static indoor unit	Low Static indoor unit	Power source	R32			R410A		
				Outdoor unit	Power source	Circuit breaker*	Outdoor unit	Power source	Circuit breaker*
Single phase	S-36PF1E5B	S-36PN1E5B	220 / 230 / 240 V	U-36PZH2E5	220 / 230 / 240 V	16 A	U-36PE2E5A	220 / 230 / 240 V	16 A
	S-50PF1E5B	S-50PN1E5B		U-50PZH2E5		16 A	U-50PE2E5A		16 A
	S-60PF1E5B	S-60PN1E5B		U-60PZH2E5		20 A	U-60PE2E5A		20 A
	S-71PF1E5B	S-71PN1E5B		U-71PZH2E5		20 A	U-71PE1E5A		20 A
	S-100PF1E5B	S-100PN1E5B		U-100PZH2E5		30 A	U-100PE1E5A		30 A
	S-125PF1E5B	S-125PN1E5B		U-125PZH2E5		30 A	U-125PE1E5A		30 A
	S-140PF1E5B	S-140PN1E5B		U-140PZH2E5		30 A	U-140PE1E5A		40 A
	S-60PF1E5B	S-60PN1E5B		U-60PZ2E5		20 A	U-60PEY2E5		20 A
	S-71PF1E5B	S-71PN1E5B		U-71PZ2E5		20 A	U-71PEY2E5		20 A
	S-100PF1E5B	S-100PN1E5B		U-100PZ2E5		30 A	U-100PEY1E5		30 A
	S-125PF1E5B	S-125PN1E5B		U-125PZ2E5		30 A	U-125PEY1E5		30 A
	S-140PF1E5B	S-140PN1E5B		U-140PZ2E5		40 A			
Three Phase	S-71PF1E5B	S-71PN1E5B	220 / 230 / 240 V	U-71PZH2E8	380 / 400 / 415 V	10 A	U-71PE1E8A	380 / 400 / 415 V	10 A
	S-100PF1E5B	S-100PN1E5B		U-100PZH2E8		10 A	U-100PE1E8A		10 A
	S-125PF1E5B	S-125PN1E5B		U-125PZH2E8		16 A	U-125PE1E8A		16 A
	S-140PF1E5B	S-140PN1E5B		U-140PZH2E8		16 A	U-140PE1E8A		16 A
	S-100PF1E5B	S-100PN1E5B		U-100PZ2E8		10 A	U-100PEY1E8		10 A
	S-125PF1E5B	S-125PN1E5B		U-125PZ2E8		16 A	U-125PEY1E8		16 A
	S-140PF1E5B	S-140PN1E5B		U-140PZ2E8		16 A	U-140PEY1E8		16 A

PACi Twin System

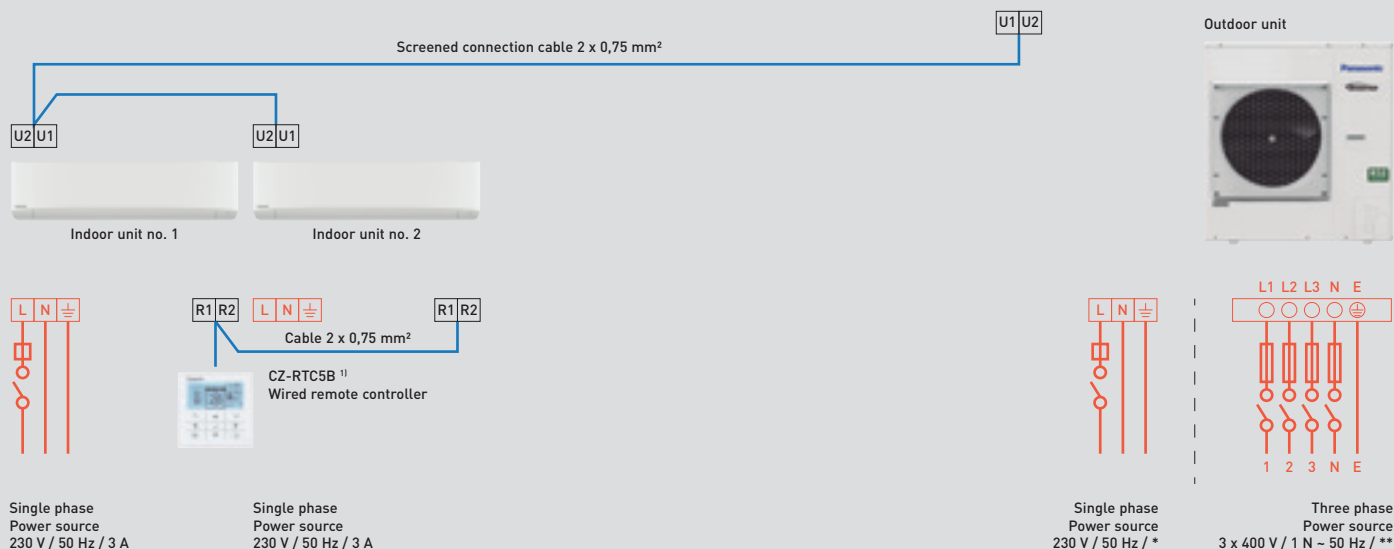

Single phase

R32			R410A		
Outdoor unit	Power source	Circuit breaker*	Outdoor unit	Power source	Circuit breaker*
U-71PZH2E5	220 / 230 / 240 V	20 A	U-71PE1E5A	220 / 230 / 240 V	20 A
U-100PZH2E5		30 A	U-100PE1E5A		30 A
U-125PZH2E5		30 A	U-125PE1E5A		30 A
U-140PZH2E5		30 A	U-140PE1E5A		40 A
U-71PZ2E5		20 A	U-100PEY1E5		30 A
U-100PZ2E5		30 A	U-125PEY1E5		30 A
U-125PZ2E5		30 A			
U-140PZ2E5		30 A			

1) Optional wireless remote controller is also possible. Wireless receivers may be required depending on indoor units.

Three phase

R32			R410A		
Outdoor unit	Power source	Circuit breaker**	Outdoor unit	Power source	Circuit breaker**
U-71PZH2E8	380 / 400 / 415 V	10 A	U-71PE1E8A	380 / 400 / 415 V	10 A
U-100PZH2E8		10 A	U-100PE1E8A		10 A
U-125PZH2E8		16 A	U-125PE1E8A		16 A
U-140PZH2E8		16 A	U-140PE1E8A		16 A
U-200PZH2E8		16 A	U-200PE2E8A		16 A
U-250PZH2E8		25 A	U-250PE2E8A		25 A
U-100PZ2E8		10 A	U-100PEY1E8		10 A
U-125PZ2E8		16 A	U-125PEY1E8		16 A
U-140PZ2E8	16 A	U-140PEY1E8	16 A		

PACi Triple System

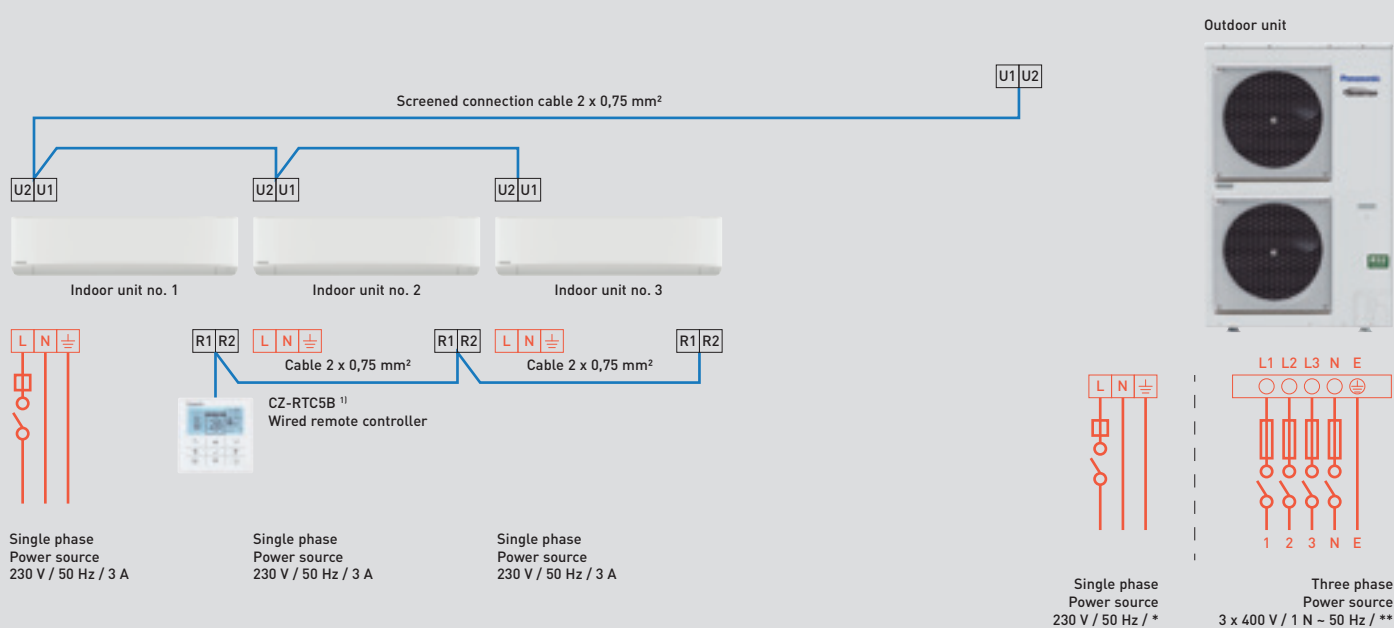

Single phase

R32			R410A		
Outdoor unit	Power source	Circuit breaker*	Outdoor unit	Power source	Circuit breaker*
U-100PZH2E5	220 /	30 A	U-100PE1E5A	220 /	30 A
U-125PZH2E5	230 /	30 A	U-125PE1E5A	230 /	30 A
U-140PZH2E5	240 V	30 A	U-140PE1E5A	240 V	40 A

1) Optional wireless remote controller is also possible. Wireless receivers may be required depending on indoor units.

Three phase

R32			R410A		
Outdoor unit	Power source	Circuit breaker**	Outdoor unit	Power source	Circuit breaker**
U-100PZH2E8	380 / 400 / 415 V	10 A	U-100PE1E8A	380 / 415 V	10 A
U-125PZH2E8		16 A	U-125PE1E8A		16 A
U-140PZH2E8		16 A	U-140PE1E8A		16 A
U-200PZH2E8		16 A	U-200PE2E8A		16 A

PACi Double-Twin System

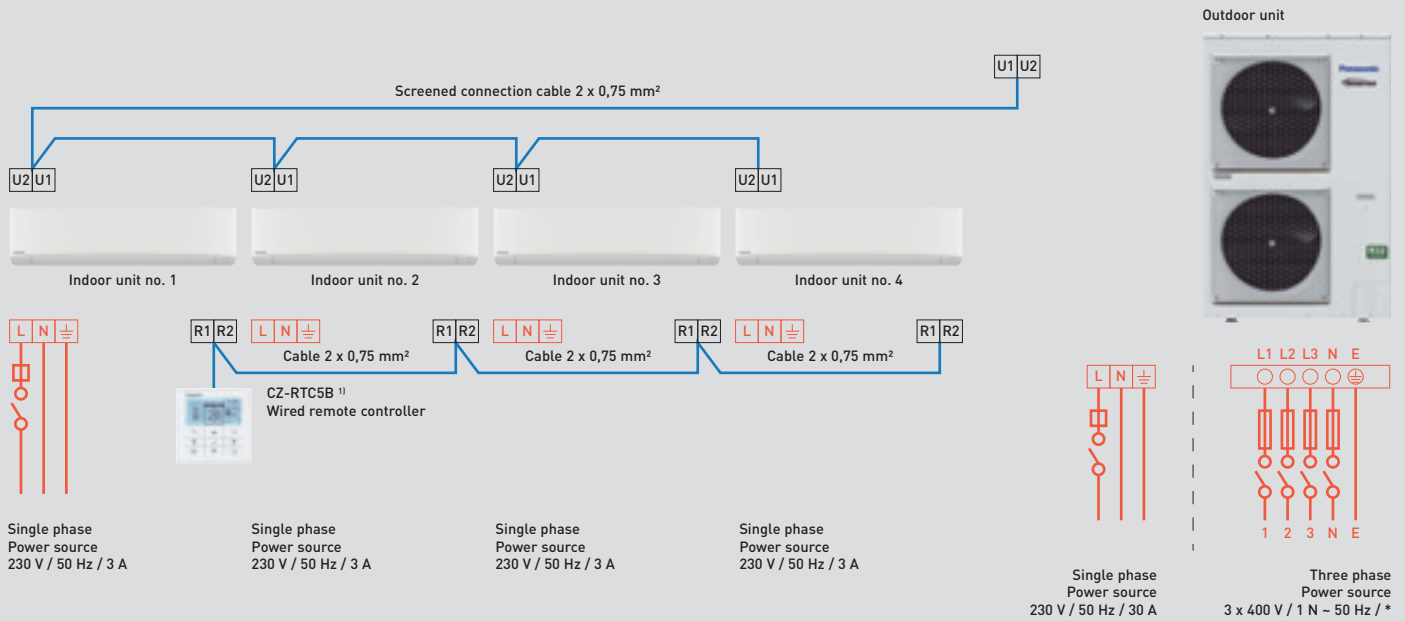

Single phase

R32			R410A		
Outdoor unit	Power source	Circuit breaker	Outdoor unit	Power source	Circuit breaker
U-125PZH2E5	220 / 230 / 240 V	30 A	U-125PE1E5A	220 / 230 / 240 V	30 A

Three phase

R32			R410A		
Outdoor unit	Power source	Circuit breaker*	Outdoor unit	Power source	Circuit breaker*
U-125PZH2E8	380 / 400 / 415 V	16 A	U-125PE1E8A	380 / 400 / 415 V	16 A
U-200PZH2E8	400 / 415 V	16 A	U-200PE2E8A	400 / 415 V	16 A
U-250PZH2E8	415 V	25 A	U-250PE2E8A	415 V	25 A

1) Optional wireless remote controller is also possible. Wireless receivers may be required depending on indoor units.

Mini ECOi Series

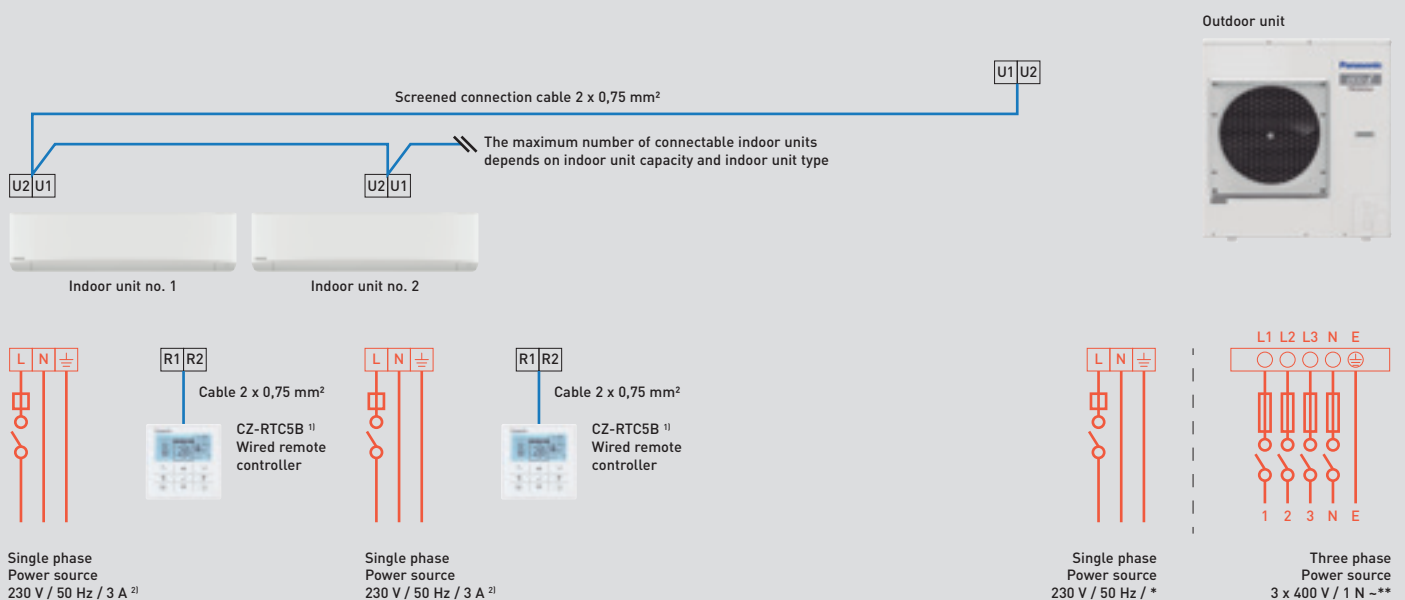

Single phase

Outdoor unit	Power source	Circuit breaker*
U-4LE2E5		20 A
U-5LE2E5	220/230/240 V	25 A
U-6LE2E5		30 A

Three phase

Outdoor unit	Power source	Circuit breaker**
U-4LE2E8		10 A
U-5LE2E8		16 A
U-6LE2E8	380/400/415 V	16 A
U-8LE1E8		16 A
U-10LE1E8		20 A

1) Wireless remote controller is also possible. Wireless receivers may be required depending on indoor units.
2) 10 A for single indoor connection to S-224ME2E5 / S-280ME2E5, in combination with U-8LE1E8 / U-10LE1E8.

ECOi EX and ECO G Series

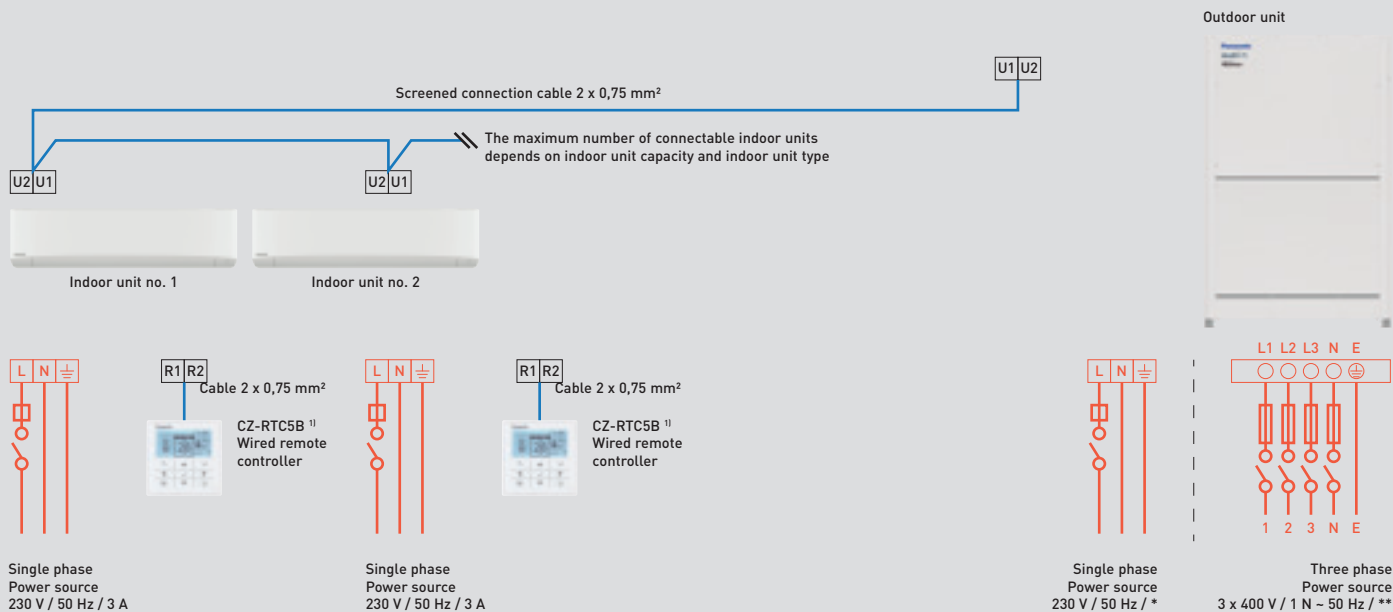

ECOi EX Series

2-Pipe			3-Pipe		
Outdoor unit	Power source	Circuit breaker**	Outdoor unit	Power source	Circuit breaker**
U-8ME2E8	380 / 400 / 415 V	16 A	U-8MF3E8	380 / 400 / 415 V	16 A
U-10ME2E8		16 A	U-10MF3E8		20 A
U-12ME2E8		20 A	U-12MF3E8		25 A
U-14ME2E8		25 A	U-14MF3E8		40 A
U-16ME2E8		30 A	U-16MF3E8		30 A
U-18ME2E8		40 A			
U-20ME2E8	40 A				

ECO G Series

2-Pipe			3-Pipe		
Outdoor unit	Power source	Circuit breaker*	Outdoor unit	Power source	Circuit breaker*
U-16GE3E5	220 / 230 / 240 V	16 A	U-16GF3E5	220 / 230 / 240 V	16 A
U-20GE3E5		16 A	U-20GF3E5		16 A
U-25GE3E5		16 A	U-25GF3E5		16 A
U-30GE3E5		16 A			

1) Wireless remote controller is also possible. Wireless receivers may be required depending on indoor units.

Hybrid GHP/EHP

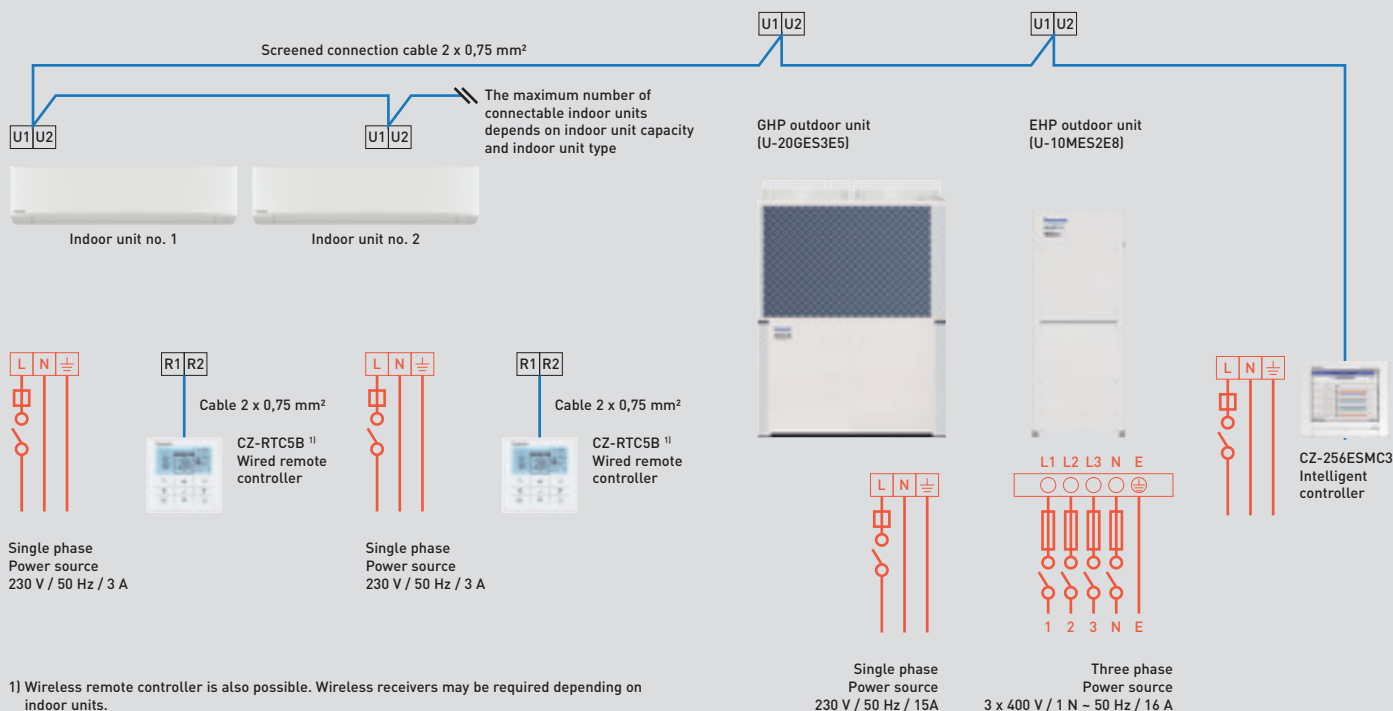

1) Wireless remote controller is also possible. Wireless receivers may be required depending on indoor units.

Due to the ongoing innovation of our products, the specifications of this catalogue are valid barring typographic errors, and may be subject to minor modifications by the manufacturer without prior warning in order to improve the product. The total or partial reproduction of this catalogue is prohibited without the express authorisation of Panasonic Marketing Europe GmbH.

Panasonic[®]

To find out how Panasonic cares for you,
log on to: www.aircon.panasonic.eu

Panasonic Marketing Europe GmbH
South-East Europe Branch Office
1117 Budapest, Alíz utca 4. – Office Garden III.



Do not add or replace refrigerant other than the specified type. Manufacturer is not responsible for the damage and deterioration in safety due to usage of the other refrigerant.
The outdoor units in this catalogue contains fluorinated greenhouse gases with a GWP higher than 150.

